

STAINLESS STEEL ENTRANCE HANDLESET



Zeus Style



Order any Stainless Steel knob or lever for the inside.

- Standard 2¹/₈" Door Prep.
- 5¹/₂" center to center
- Schlage C Keyway

Zeus Style

Description	Product Code	Inside Stainless Steel Knob or Lever Style	Finish	List Price
Single Cylinder	S40001	Refer to P84 & P85 ▼ ▼	Brushed Stainless Steel (SS)	\$300.00
Double Cylinder	S40002			
Dummy	S40000			

Interconnect Device	Product Code	List Price
Available for this style	443	\$52.00

Standard latch is 2³/₈" backset. Specify 2³/₄" backset if required.
Handing required if lever used on inside, or if interconnect device is specified.

STAINLESS STEEL DEADBOLTS



- Standard Door Prep & Installation
- Schlage C Keyway
- Solid Brass Cylinder
- Hardened Steel Bolt
- Heavy Gauge Understrike

Round Deadbolts

Description	Product Code	Finish	List Price
Single Cylinder Deadbolt	S50001	Brushed Stainless Steel (SS)	\$48.00
Double Cylinder Deadbolt	S50002		\$53.00



Square Deadbolts

Description	Product Code	Finish	List Price
Single Cylinder Deadbolt	S50003	Brushed Stainless Steel (SS)	\$48.00
Double Cylinder Deadbolt	S50023		\$53.00

Standard latch is 2³/₈" backset. Specify 2³/₄" backset if required.

Stainless Steel

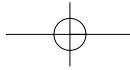

TUBULAR STAINLESS STEEL LEVERSETS & CAST STAINLESS STEEL KNOBS

Complete set includes Latch and Strike Plate



Cologne Lever
with Disk Rosette



Kiel Lever
with Beveled Rosette



Stuttgart Lever
with Disk Rosette

Description	Product Code	Rosette Style	Lever Style	Finish	List Price
Passage set	S100	Beveled (01) Disk (02) Square (03)	Cologne (CO) Kiel (KL) Stuttgart (ST)	Brushed Stainless Steel (SS)	\$80.00
Privacy set	S200				
Dummy, Pair	S300				

Stainless Steel



Octagon Knob
with Square Rosette



Round Knob
with Beveled Rosette



Octagon Knob
with Round Rosette

Description	Product Code	Rosette Style	Knob Style	Finish	List Price
Passage set	S100	Beveled (01) Disk (02) Square (03)	Octagon Knob (OK) Round Knob (RK)	Brushed Stainless Steel (SS)	\$105.00
Privacy set	S200				
Dummy, Pair	S300				

Standard latch is 2 3/8" backset. Specify 2 3/4" backset if required.
Handing required for Leversets.

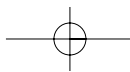

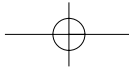

CAST STAINLESS STEEL LEVERSETS

Complete set includes Latch and Strike Plate



Ajax Lever
with Disk Rosette



Achilles Lever
with Beveled Rosette



Athena Lever
with Square Rosette



Hercules Lever
with Disk Rosette



Hermes Lever
with Beveled Rosette



Poseidon Lever
with Square Rosette

Stainless Steel

Rosette Styles

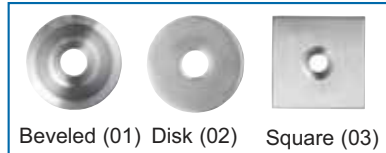

Beveled (01) Disk (02) Square (03)

Description	Product Code	Rosette Style	Lever Style	Finish	List Price
Passage set	S100	Beveled (01) Disk (02) Square (03)	Achilles (AC)	Brushed Stainless Steel (SS)	\$130.00
Privacy set	S200		Ajax (AJ)		
			Athena (AT)		
Dummy, Pair	S300		Hercules (HS)		
			Hermes (HE)		
			Poseidon (PO)		

Standard latch is 2³/₈" backset. Specify 2³/₄" backset if required.
Handing required for Leversets.

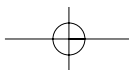

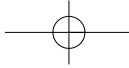

CAST STAINLESS STEEL LEVERSETS

Complete set includes Latch and Strike Plate

Pierced Stainless Steel Leversets



Comet Lever with Disk Rosette



Meteor Lever with Disk Rosette

Description	Product Code	Rosette Style	Lever Style	Finish	List Price
Passage set	— M100	{ Beveled (01) Disk (02) Square (03) }	{ Comet (CT) Meteor (MT) }	Brushed Stainless Steel (SS)	\$130.00
Privacy set	— M200				
Dummy, Pair	— M300				

Natural Wood Inlays Leversets



Ebony Round

Mahogany Round



Ebony Slotted

Mahogany Slotted

Description	Product Code	Rosette Style	Lever Style	Inlay Pattern	List Price
Passage set	— S100	{ Beveled (01) Disk (02) Square (03) }	Athena (AT)	{ Ebony Round (EBR) Ebony Slotted (EBS) Mahogany Round (MAR) Mahogany Slotted (MAS) }	\$155.00
Privacy set	— S200				
Dummy, Pair	— S300				

Natural Bronze Inlays Leversets



Bronze Round



Bronze Slotted

Description	Product Code	Rosette Style	Lever Style	Inlay Pattern	List Price
Passage set	— S100	{ Beveled (01) Disk (02) Square (03) }	Athena (AT)	{ Bronze Round (BRR) Bronze Slotted (BRS) }	\$165.00
Privacy set	— S200				
Dummy, Pair	— S300				

Standard latch is 2³/₈" backset. Specify 2³/₄" backset if required.
Handing required for Leversets.

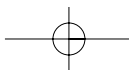

Stainless Steel

BRIGHANDLE LEVER DESIGNS BY EMTEK

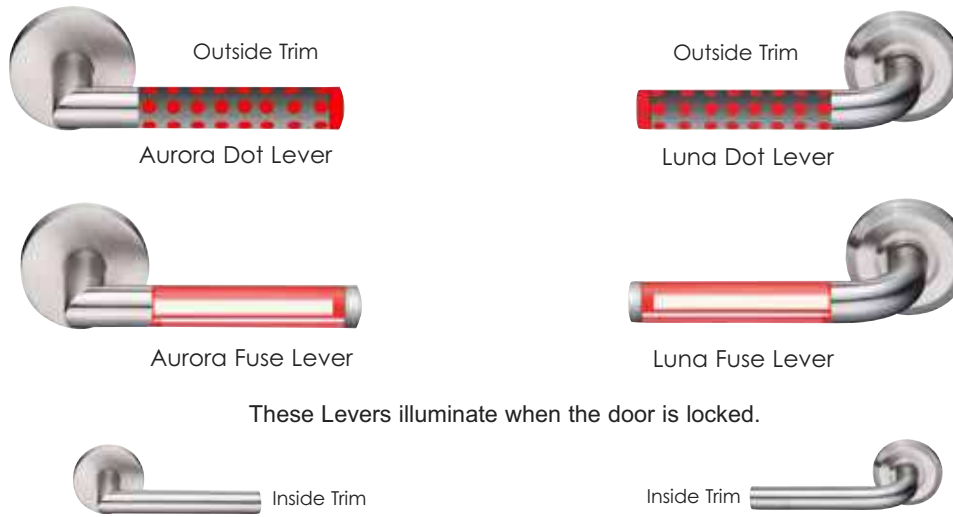

PRIVACY FUNCTION

Description	Product Code	Rosette Style	Lever Style	Finish	List Price
Privacy Set	B200	Beveled (01) Disk (02) Square (03)	Aurora Dot (AUD) Aurora Fuse (AUF) Luna Dot (LUD) Luna Fuse (LUF)	Brushed Stainless Steel (SS)	\$200.00

Stainless Steel

STAINLESS STEEL SIDEPLATE



Hercules Lever with Modern Plate
 • Standard 2 1/8" Door Prep
 • Available Only in Non-Keyed Version

Description	Product Code	Inside Stainless Steel Knob or Lever Style	Finish	List Price
Passage	S801	Refer to P84 & P85 ▼ ▼	Brushed Stainless Steel (SS)	\$180.00
Privacy	S802			
Dummy Pair	S800			

Standard latch is 2 3/8" backset. Specify 2 3/4" backset if required.
Handing required for Leversets.

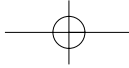

STAINLESS STEEL BATH HARDWARE



Stainless Steel Towel Bar
with Style 1 Rosettes

Description	Product Code	Rosette	Finish	List Price
Towel Bar 18"	S7010	Beveled (01) Disk (02) Square (03)	Brushed Stainless Steel (SS)	} — \$76.00 } — \$84.00 } — \$90.00
Towel Bar 24"	S7020			
Towel Bar 30"	S7030			



Stainless Steel Towel Ring
with Style 1 Rosette

Description	Product Code	Rosette	Finish	List Price
Towel Ring	S7300	Beveled (01) Disk (02) Square (03)	Brushed Stainless Steel (SS)	} \$48.00



Stainless Steel Bar Paper Holder
with Style 1 Rosette

Description	Product Code	Rosette	Finish	List Price
Bar Paper Holder	S7210	Beveled (01) Disk (02) Square (03)	Brushed Stainless Steel (SS)	} \$50.00
Spring Rod Paper Holder	S7220			



Stainless Steel Spring Rod Paper Holder
with Style 2 Rosette



Stainless Steel Single Hook
with Small Disk Plate

Description	Product Code	List Price
Robe Hook with Small Disk Plate	S7100SS	} \$24.00

Rosette Styles



Stainless Steel

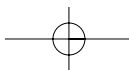

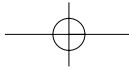

LEATHER CABINET PULLS & STAINLESS STEEL CABINET HARDWARE



Brown Leather Pull, 5"



Black Leather Pull, 8¹/₂"



Black Leather Pull, 14¹/₂"

Description	Product Code	Overall Length	List Price
Cabinet Pull 3" C-to-C	S86521BLKST S86521BRNST	5"	\$8.00
Cabinet Pull 3 ¹ / ₂ " C-to-C	S86522BLKST S86522BRNST	5 ¹ / ₂ "	\$9.00
Cabinet Pull 4" C-to-C	S86523BLKST S86523BRNST	6 ¹ / ₂ "	\$10.00
Cabinet Pull 6" C-to-C	S86524BLKST S86524BRNST	8 ¹ / ₂ "	\$12.00
Cabinet Pull 8" C-to-C	S86525BLKST S86525BRNST	10 ¹ / ₂ "	\$16.00
Cabinet Pull 12" C-to-C	S86526BLKST S86526BRNST	14 ¹ / ₂ "	\$22.00

Description	Product Code	List Price
-------------	--------------	------------



Delta Pull 3"	S60030SS	} \$15.00
Delta Pull 3.5"	S60035SS	
Delta Pull 4"	S60040SS	

Description	Product Code	List Price
-------------	--------------	------------



Dome Knob	S61113SS	\$12.00
-----------	----------	---------



Mushroom Knob	S61213SS	\$12.00
---------------	----------	---------

Stainless Steel

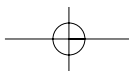

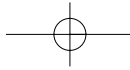

STAINLESS STEEL CABINET PULLS

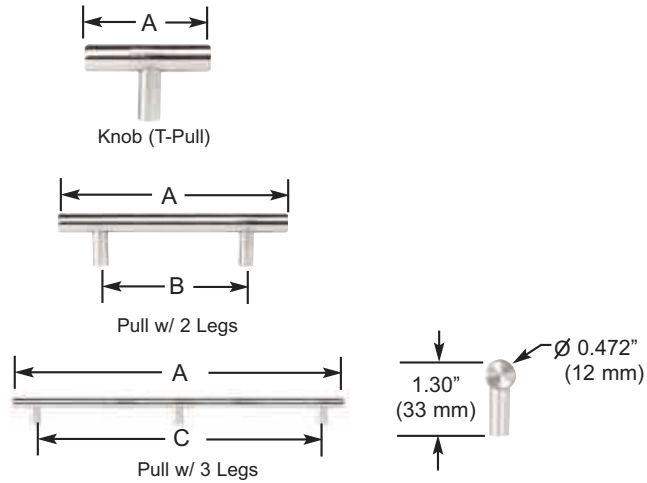

Description	Product Code	Center to Center	Overall Length	List Price
Cabinet Knob A=2"	S62001SS	2"	2"	\$4.00
<hr/>				
Drawer Pull A=5", B=3"	S62002SS	3"	5"	\$6.00
Drawer Pull A=5 1/2", B=3 1/2"	S62003SS	3 1/2"	5 1/2"	\$6.60
Drawer Pull A=6 1/2", B=4"	S62004SS	4"	6 1/2"	\$7.00
Drawer Pull A=7 1/2", B=5"	S62005SS	5"	7 1/2"	\$8.00
Drawer Pull A=8 1/2", B=6"	S62006SS	6"	8 1/2"	\$9.00
Drawer Pull A=10 1/2", B=8"	S62007SS	8"	10 1/2"	\$11.00
Drawer Pull A=12 1/2", B=10"	S62008SS	10"	12 1/2"	\$12.00
Drawer Pull A=14 1/2", B=12"	S62009SS	12"	14 1/2"	\$14.00
Drawer Pull A=18 1/2", B=16"	S62010SS	16"	18 1/2"	\$17.00
Drawer Pull A=26 1/2", B=24"	S62011SS	24"	26 1/2"	\$22.00
Drawer Pull A=30 1/2", B=28"	S62012SS	28"	30 1/2"	\$24.00
Drawer Pull A=34 1/2", B=32"	S62013SS	32"	34 1/2"	\$28.00
Drawer Pull A=38 1/2", B=36"	S62014SS	36"	38 1/2"	\$30.00
<hr/>				
Drawer Pull A=48 1/2", C=46"	S62015SS	46"	48 1/2"	\$38.00
Drawer Pull A=56 1/2", C=54"	S62016SS	54"	56 1/2"	\$42.00

