

Specification Sheet - Door Configuration #1

Trim and Cylinders for Multi Point Locks

Swinging Patio Door Hardware - Set includes Plates, Handles and Cylinders (where applicable)
G-U®, Marvin Integrity®, KML by Andersen®, Atrium®, Superior®

Keyed with American Cylinder (for Active Door, Schlage Keyway, Rekeyable)

1½" x 11" Plates, Product Codes 1111, 1131, 1151, 1171, 1191

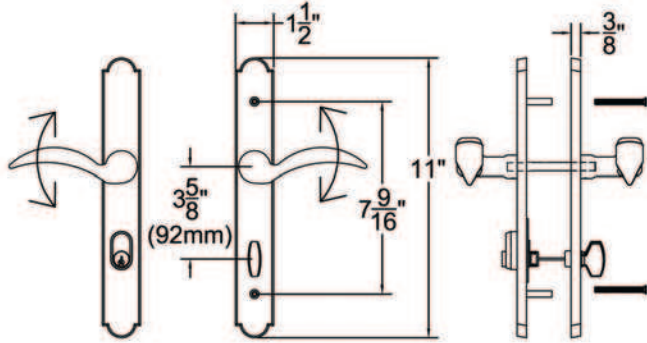

2" x 10" Plates, Product Codes 1121, 1141, 1161, 1181, 1101

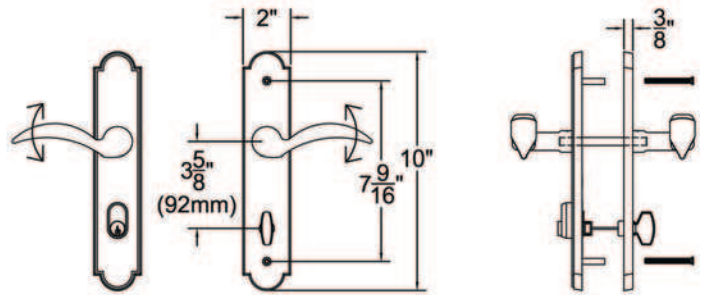

Non-Keyed, Passage (for Semi-Active Door)

1½" x 11" Plates, Product Codes 1112, 1132, 1152, 1172, 1192

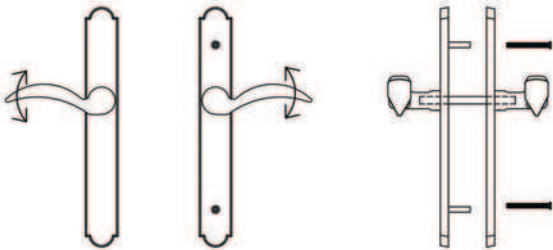

2" x 10" Plates, Product Codes 1122, 1142, 1162, 1182, 1102

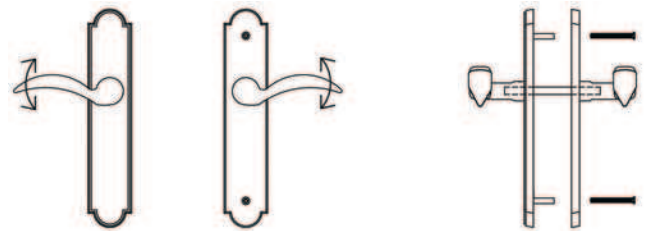

Non-Keyed, American Style Thumbturn Inside (for Active Door)

1½" x 11" Plates, Product Codes 1113, 1133, 1153, 1173, 1193

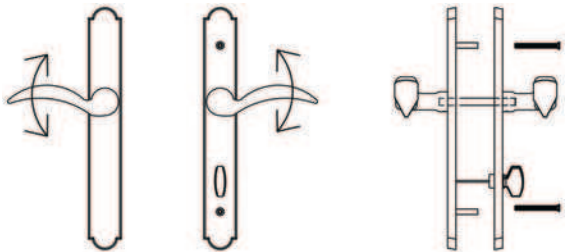

2" x 10" Plates, Product Codes 1123, 1143, 1163, 1183, 1103

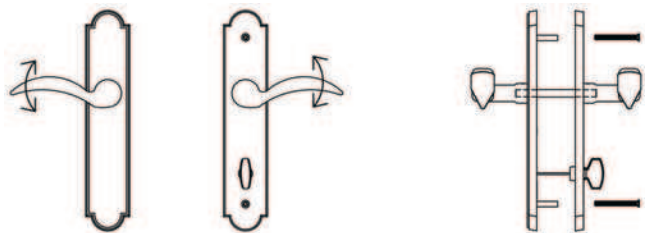

Non-Keyed, Fixed Handle Outside, Operating Handle Inside (for Semi-Active Door)

1½" x 11" Plates, Product Codes 1114, 1134, 1154, 1174, 1194

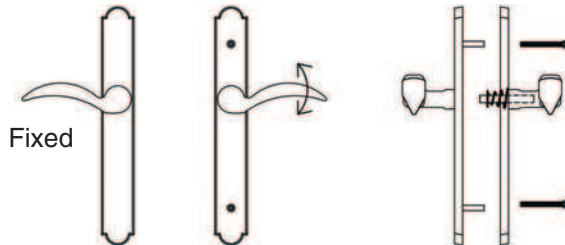

2" x 10" Plates, Product Codes 1124, 1144, 1164, 1184, 1104

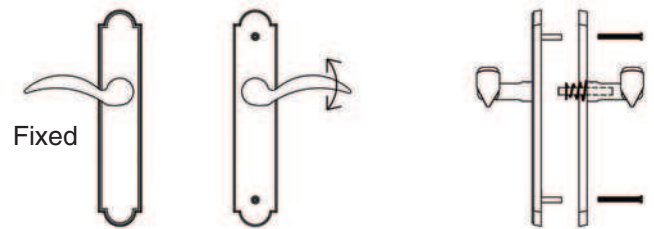

Dummy Pair (for Non-Active Door)

1½" x 11" Plates, Product Codes 1115, 1135, 1155, 1175, 1195

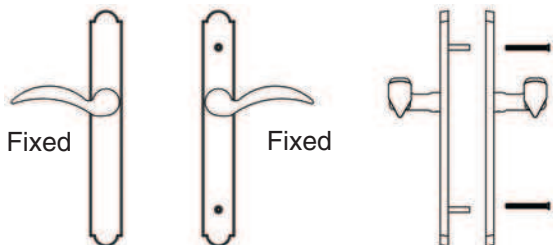

2" x 10" Plates, Product Codes 1125, 1145, 1165, 1185, 1105

